



PINTA

Piiri

Laine

Tiili

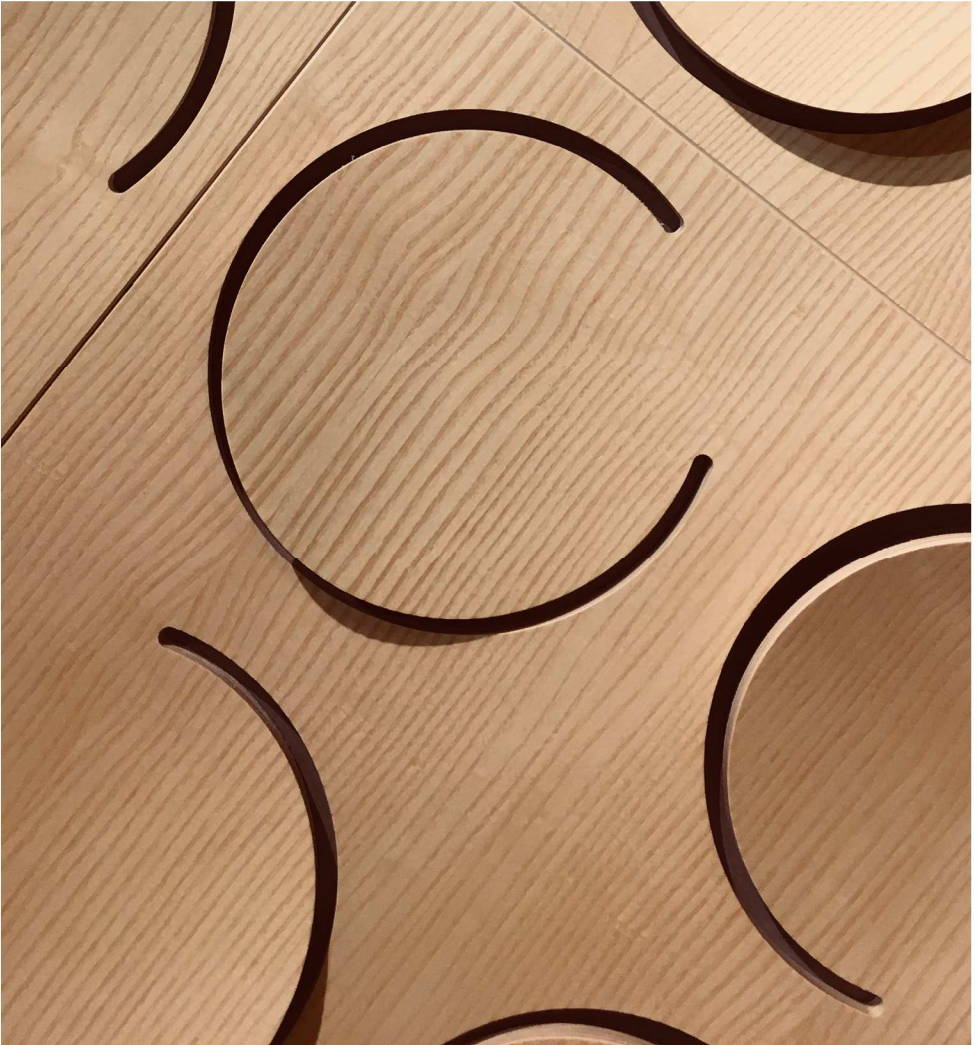

Pinta is a modular interior decoration system for internal walls.

Moulded (Piiri, Tiili and Laine models) interior panels are suitable for private homes and public spaces. Rhythmic three-dimensional wooden surface revives the wall surfaces and wood offers warmth and value characteristic to the material. Panel surfaces are perforated and shaped to give the surface a three-dimensional look. Panels can be stained or coated with different wood veneers of natural shades. The surface can also be utilized for displaying products in shops and storing small items at home by designing the surface with different-sized shelves and hooks. Even just one 600x600 module on home wall is a piece of art.

Pinta on modulaarinen sisustuslevyjärjestelmä sisätilojen seinille.

Muotopuristetut sisustuslevyt sopivat niin yksityisiin koteihin kuin julkisiin tiloihinkin. Rytmikäs, kolmiulotteinen puupinta elävöittää seinäpintoja ja puu antaa tilalle materiaalille ominaista lämpöä ja arvokkuutta. Levyjen pinnat on aukotettuja ja muotoiltu niin että ne tekevät pinnasta kolmiulotteisen. Levy voidaan pinnoittaa erilaisilla puuviiluilla luonnonvärisenä tai petsattuna. Pintojen muotoilua voi erikokoisten hyllyjen ja koukkujen avulla hyödyntää myös myymälöiden tuotteiden esillepanossa ja kodin pientavaroiden säilyttämisessä. Jo yksi 600x600 moduli kodin seinällä on piece of art.

Vivero Oy

info@vivero.fi

www.vivero.fi

Tiili

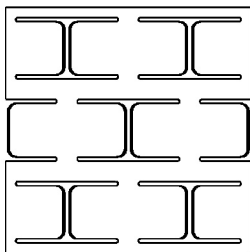

Laine

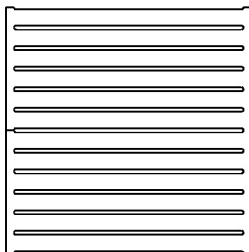

Piiri

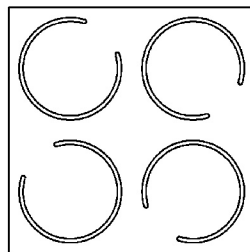

Pinta modular
interior decoration
system for internal
walls.

Surface veneer

Birch / cut and sliced,
oak, ash, maple, alder,
teak, mahogany and
other veneers as
needed. Ask from
Vivero before making a
plan.

Pintaviilu

Koivu / leikattu ja
sorvattu, tammi, saarni,
vaahtera, leppä, tiikki,
mahonki ja muita viiluja
tarvittaessa. Kysy
Viverolta suunnitelmaa
tehdessä.



Piiri



Tiili



Laine



Piiri

PINTA

Laine

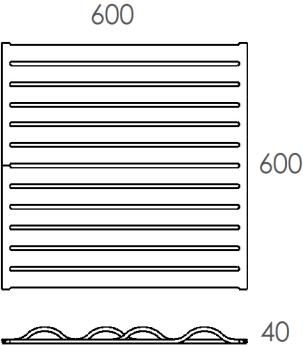

PINTA

Laine

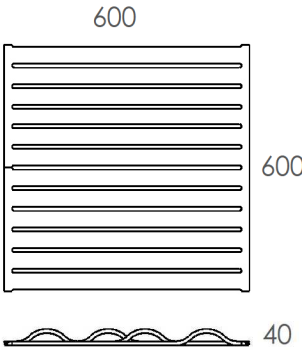

PINTA

Laine

Shelf and hook

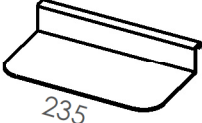
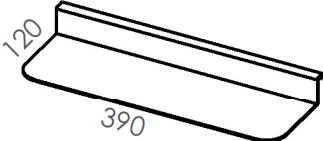

PINTA

Laine

Shelf and hook

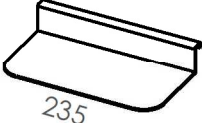
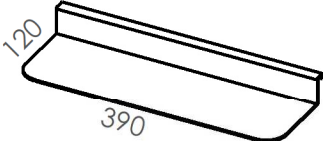



PINTA

Piiri

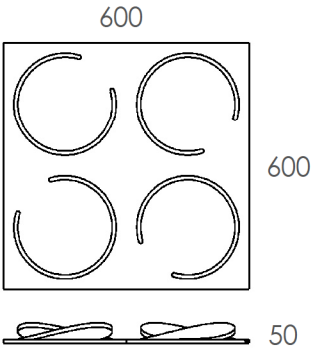

PINTA

Piiri

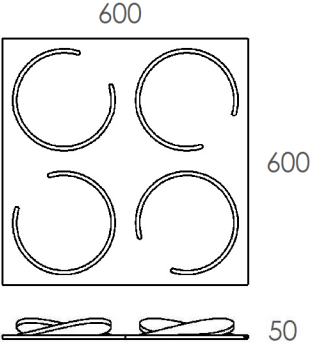

PINTA

Piiri

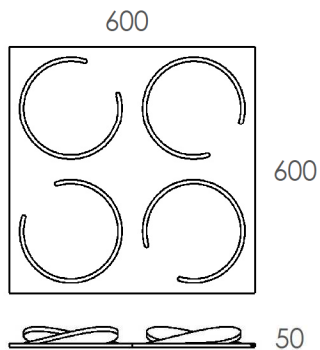

PINTA

Tili

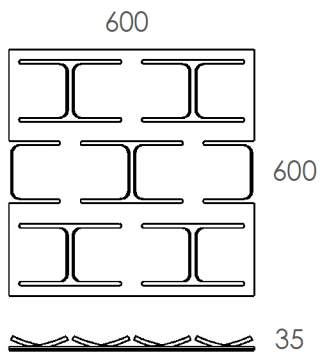

PINTA

Tili

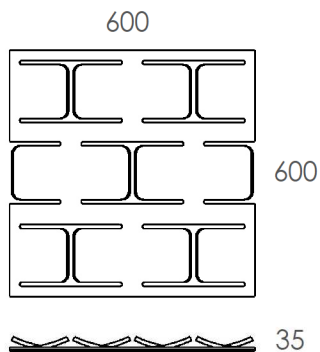

PINTA

Tiili

Shelf and hook

Hylly ja koukku

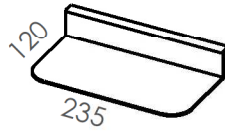

PINTA

Wooden L Lipping
Puinen L-reunalista



PINTA

Aluminium mounting profile (A)

Alumiininen kiinnitys- ja reunalista (A)



PINTA

Aluminium mounting profile (A)

Alumiininen kiinnitys- ja reunalista (A)

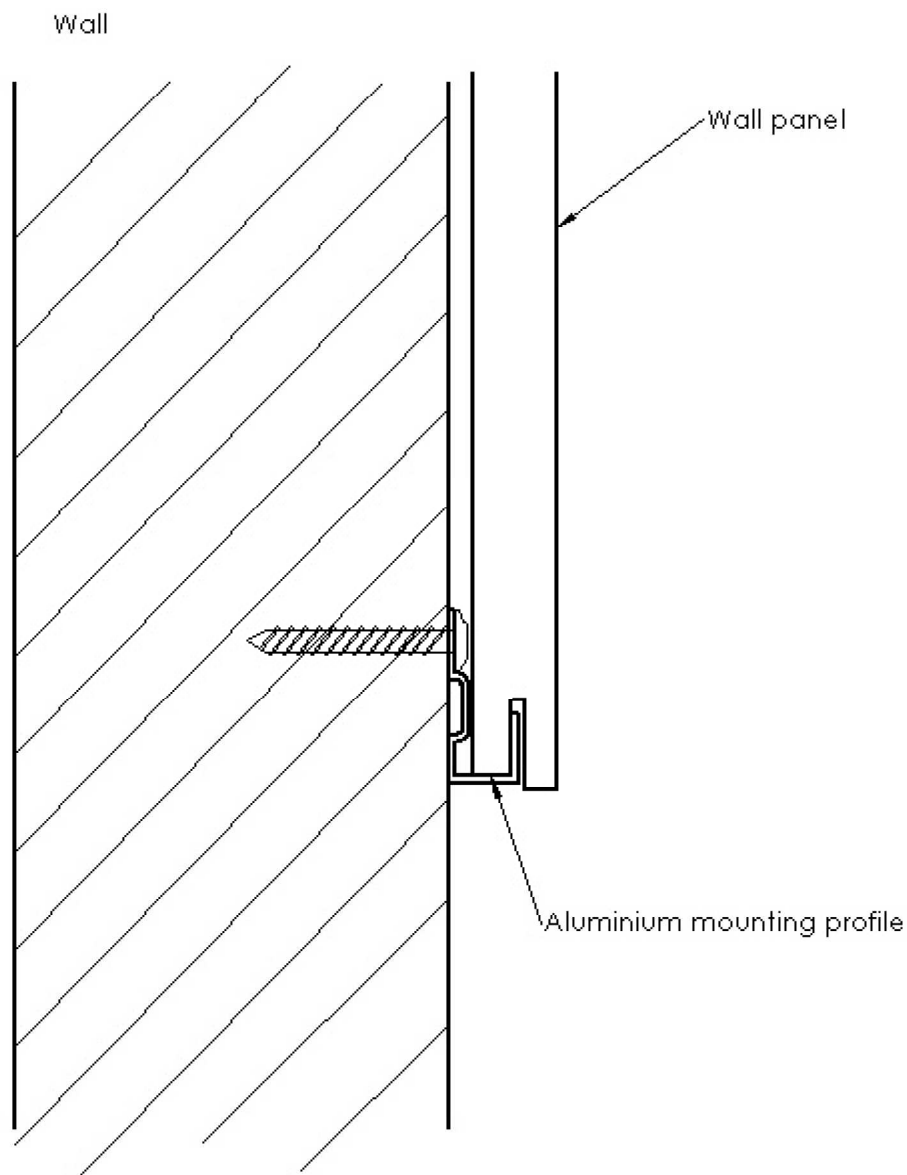

PINTA

Aluminium mounting profile (B)

Alumiininen kiinnityslista (B)

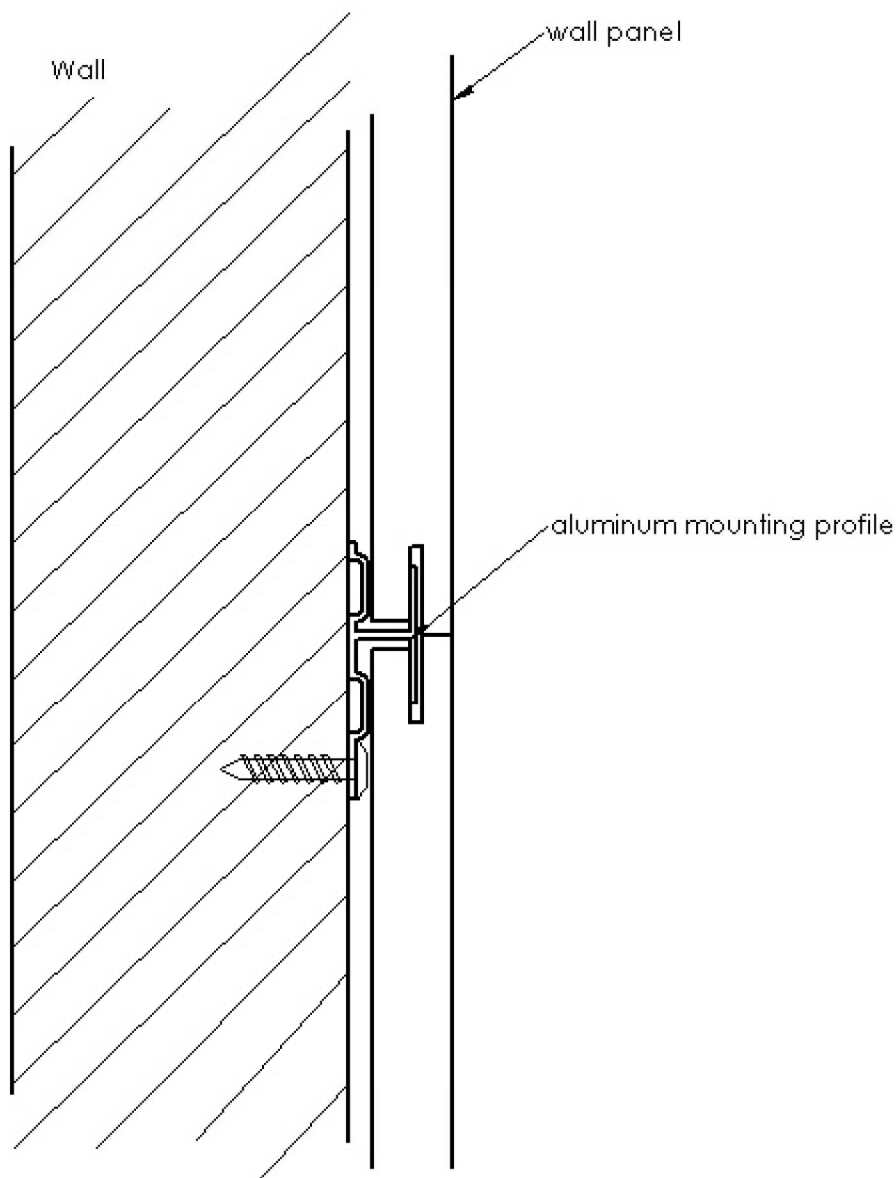

PINTA

Aluminium mounting profile (A)

Alumiininen kiinnitys- ja reunalista (A)

4 mod.

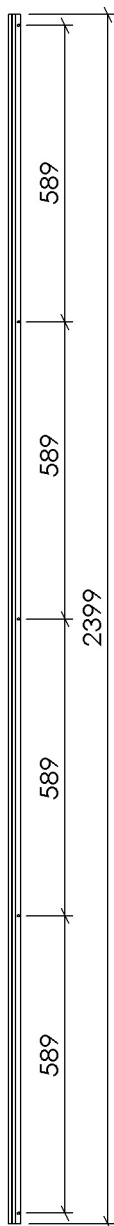

3 mod.

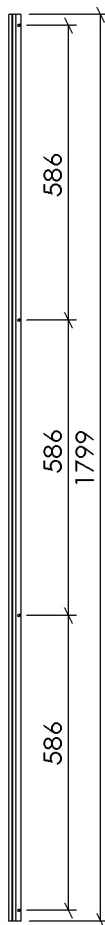

2 mod.

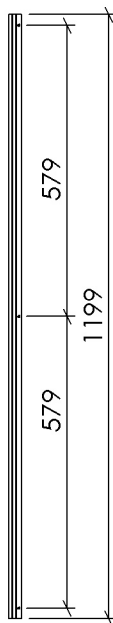

1 mod.

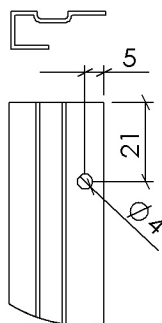

DETAIL A
SCALE 1 : 2

PINTA

Aluminium mounting profile (B)

Alumiininen kiinnityslista (B)

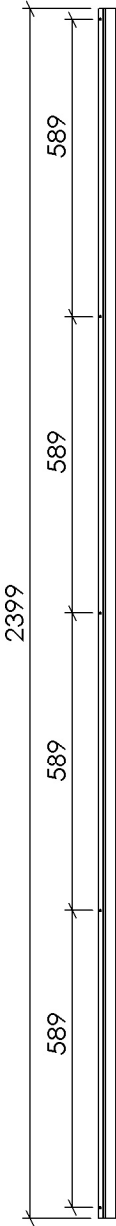

4 mod.

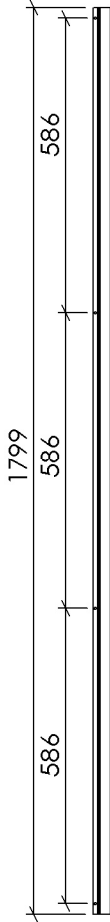

3 mod.

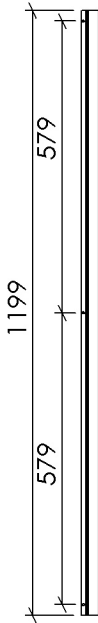

2 mod.

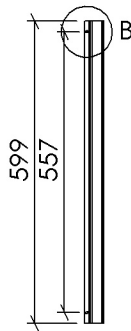

1 mod.

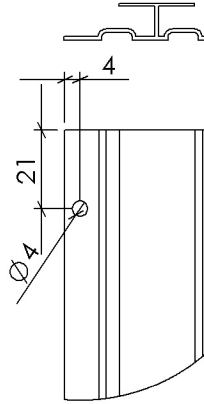

DETAIL B
SCALE 1 : 2

PINTA

Laine

installation instructions

Asennusohjeet

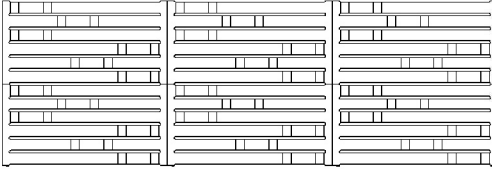

1. Fix first aluminium mounting profile (A) to wall
Asenna ensimmäinen asennuslista (A) seinään

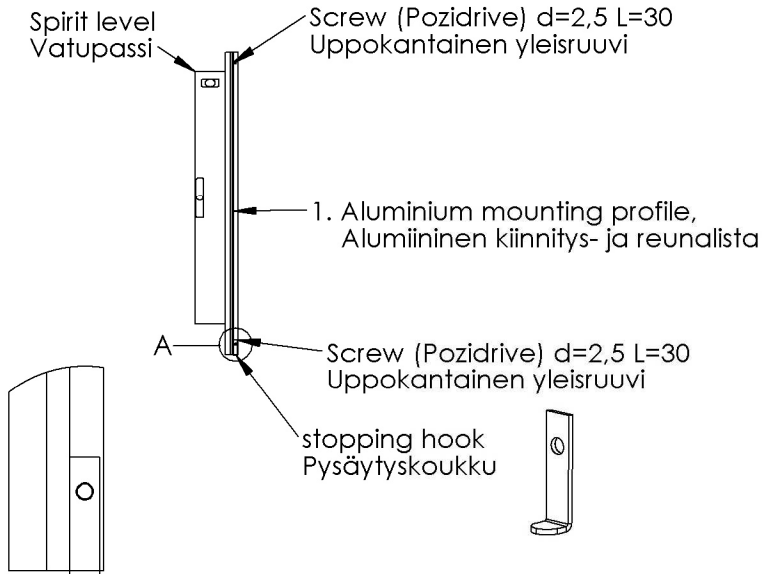

DETAIL A
SCALE 1 : 2

2. Add the first wall panel to mounting profile
Lisää ensimmäinen seinälevy asennuslistaan

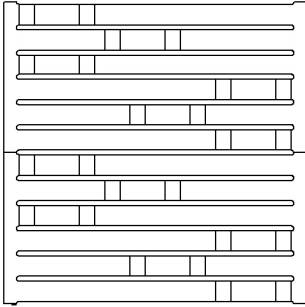

3. Add second mounting profile (B)
Lisää toinen asennuslista (B)

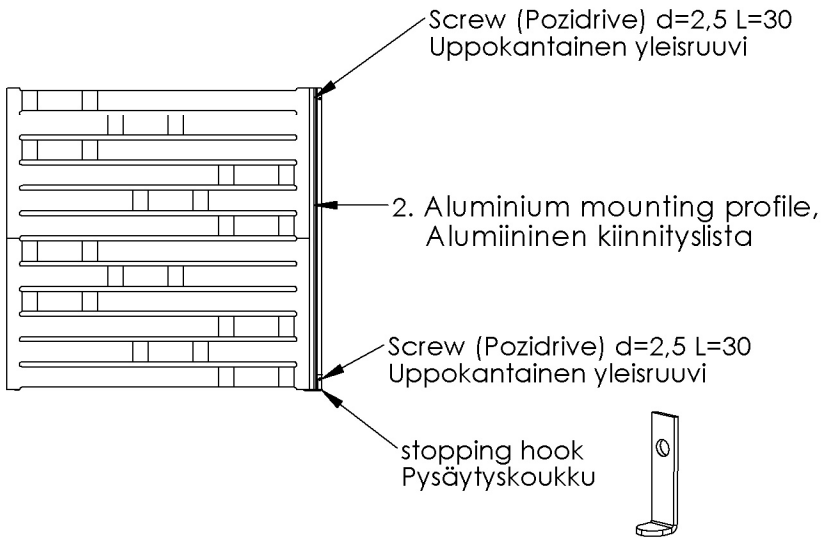

4. Add second wall panel
Lisää toinen seinälevy

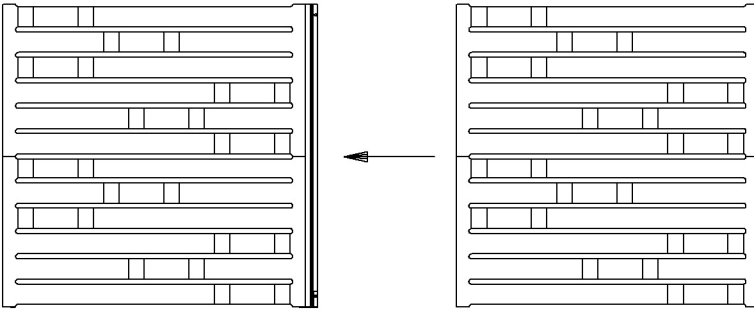

5. Add third mounting profile (B)
Lisää kolmas asennuslista (B)

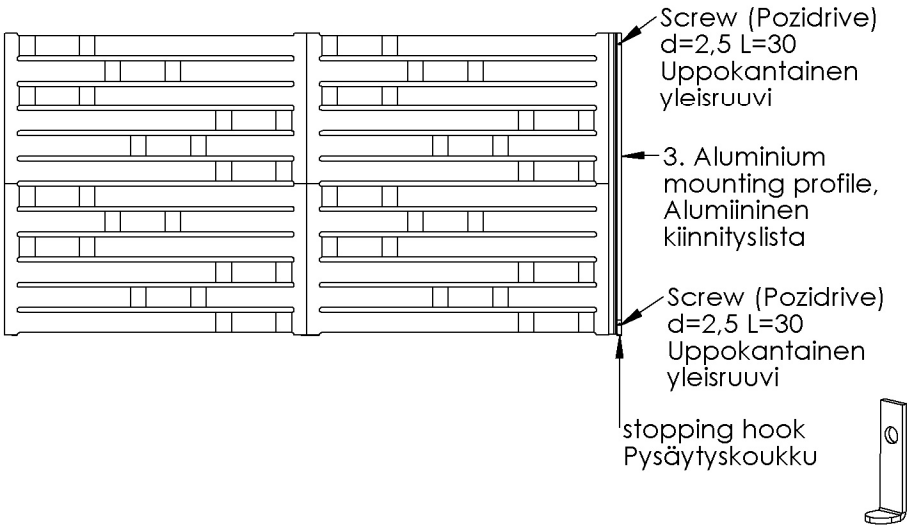

6. Add fourth mounting profile (A) and third wall panel
Lisää neljäs asennuslista (A) ja kolmas seinälevy

4. Aluminium
mounting profile,
Alumiininen
reunalista

Screw (Pozidrive)
d=2,5 L=30
Uppokantainen
yleisruuvi

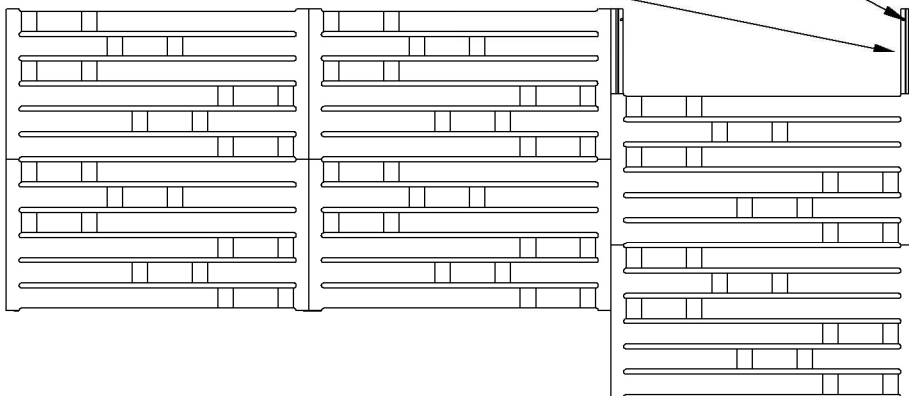

7. Add fourth mounting profile (A) and third wall panel
Lisää neljäs asennuslista (A) ja kolmas seinälevy

4. Aluminium
mounting profile,
Alumiininen
reunalista

Screw (Pozidrive)
d=2,5 L=30
Uppokantainen
yleisruuvi

stopping hook
Pysäytyskoukku

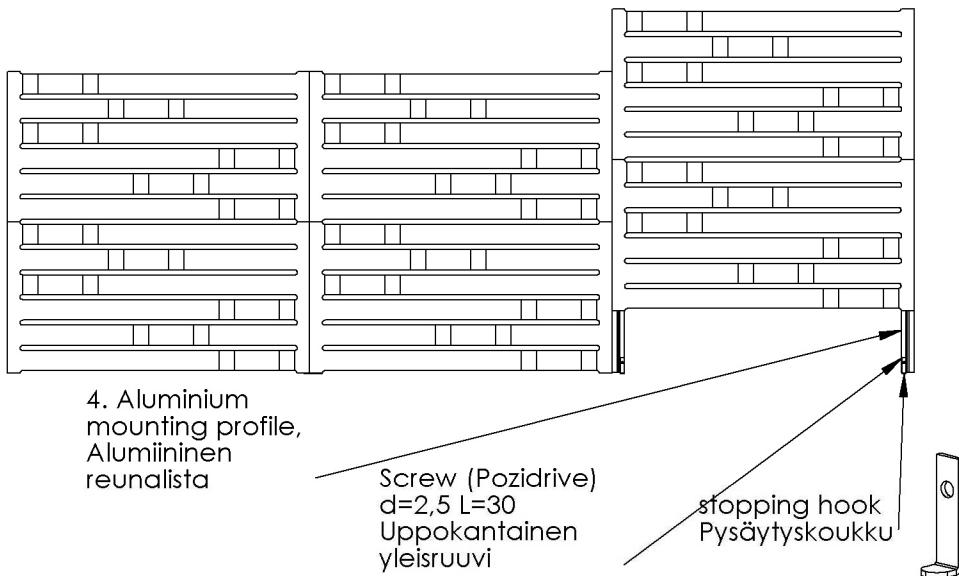

PINTA

Piiri

installation instructions

Asennusohjeet

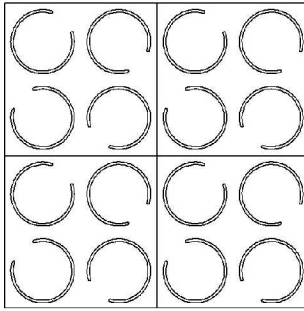

1. Fix first aluminium mounting profile (A) to wall
Asenna ensimmäinen asennuslista (A) seinään

Screw (Poizidrive)
d=2,5 L=30
Uppokantainen
yleisruuvi

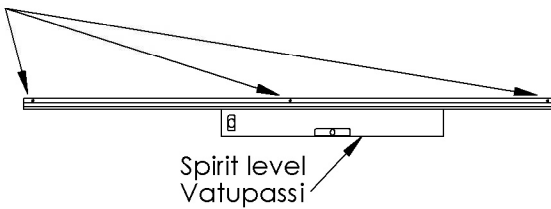

2. Add wall panels to mounting profile (A)
Lisää seinälevyt asennuslistaan (A)

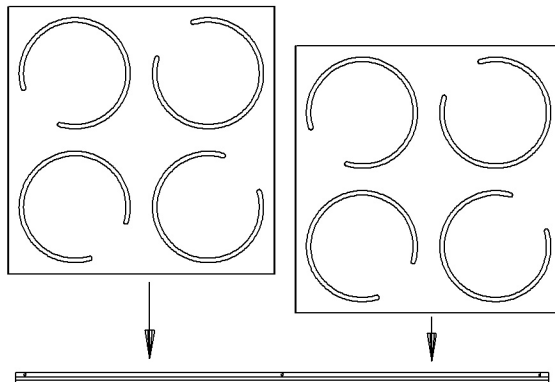

3. Add second mounting profile (B)
Lisää toinen asennuslista (B)

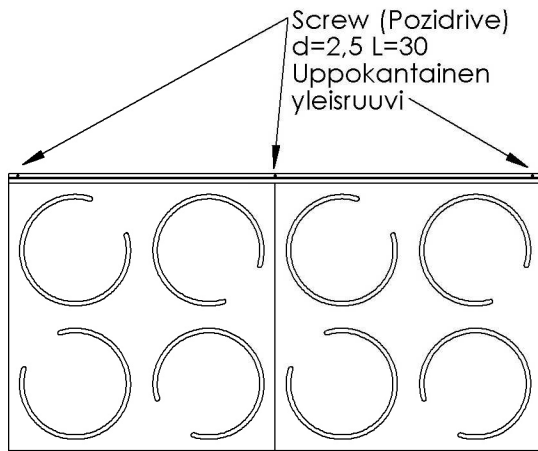

4. Add mounting profile (A) and one wall panel
Lisää asennuslista (A) ja seinälevy

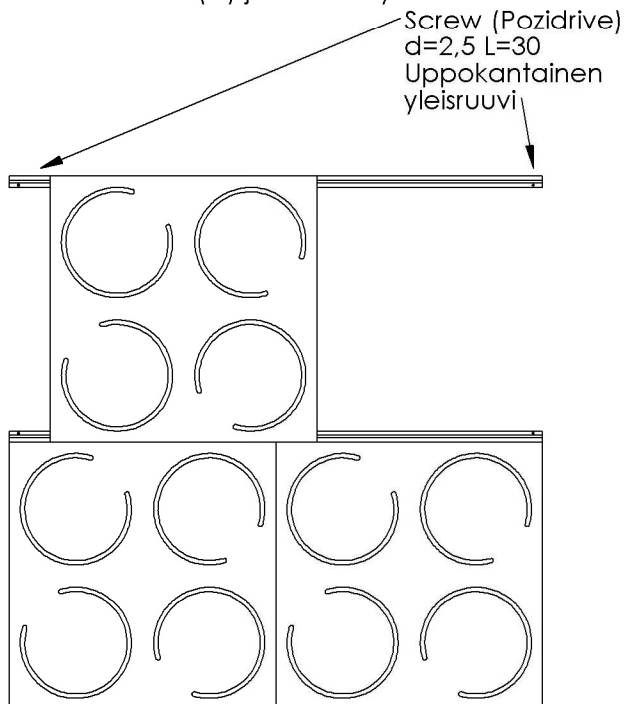

5. Add wall panel
Lisää seinälevy

Screw (Pozidrive)
d=2,5 L=30
Uppokantainen
yleisruuvi

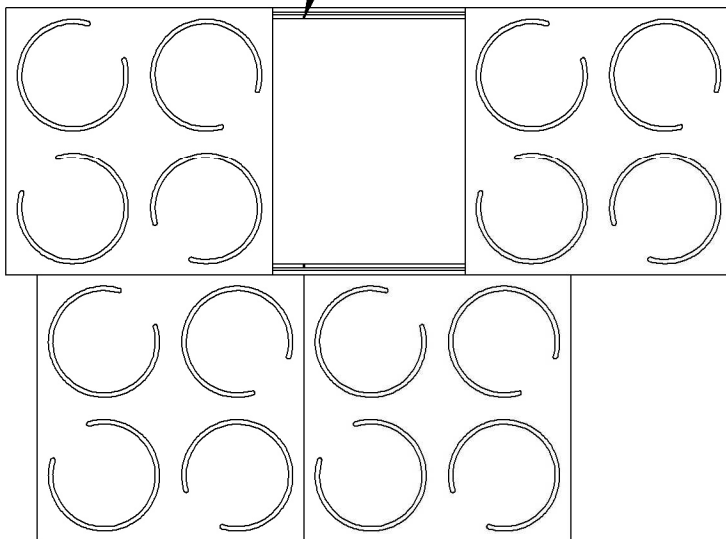

- 6.

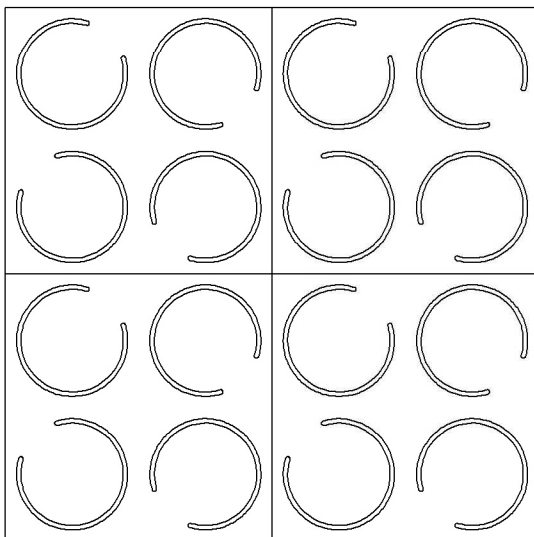

PINTA

Tiili

The instructions for mounting the wall panels to achieve the correct pattern. Fix mounting profiles in the same way as Piiri wall panels

Seinälevyjen ladontaohje oikeanlaisen kuvion saavuttamiseksi. Asenna kiinnityslistat samalla tavalla kuin Piiri levyissä

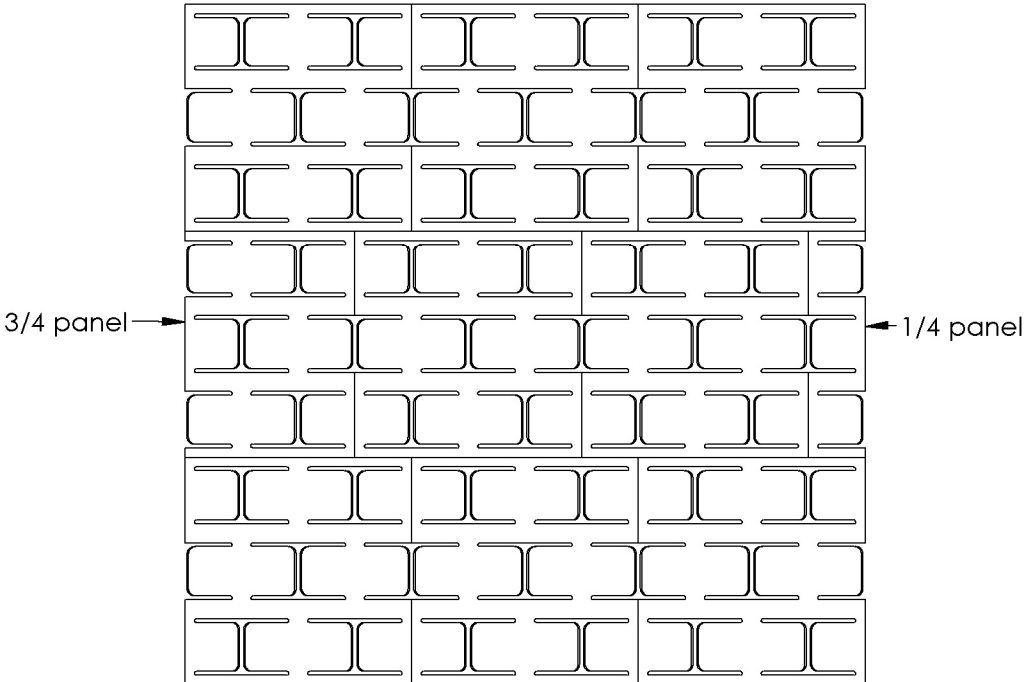

PINTA

sockets and light switches

Pistorasiat ja valokatkaisijat

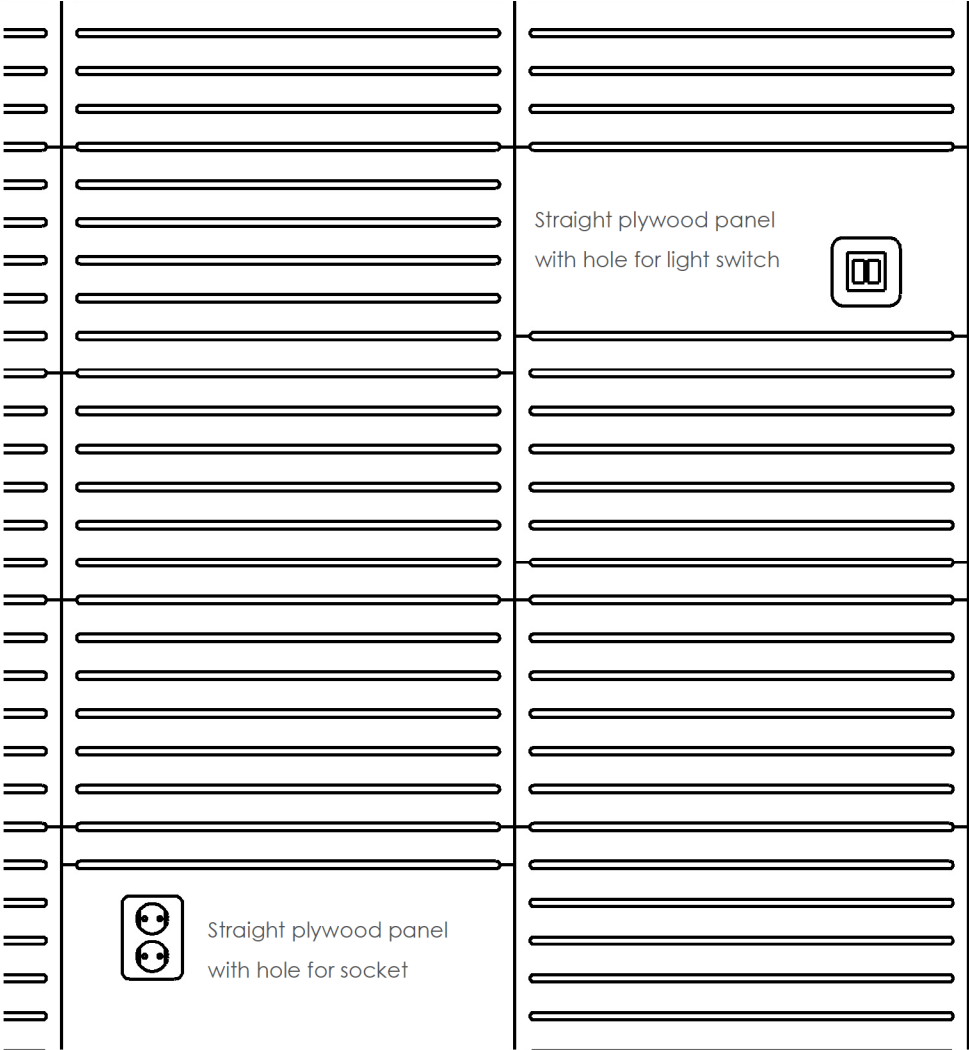
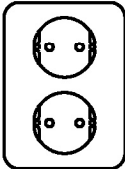
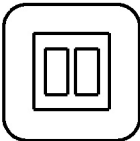

Straight plywood panel
with hole for light switch



Straight plywood panel
with hole for socket

PINTA

Door and corners

Oviaukko ja seinien nurkkaukset

Straight plywood panel

